

SPECIFICATION



受 控

Customer : QUARTZ
Applied To :
Product Name : MIC
Model Name : KPCM-45H22LC33-56dB-1731-Green
Drawing No. : KIC1731

Signature of Appronal

--

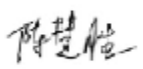
Signature of KEPO

Approved by	Checkde by	Issued by	Date
			2013.01.23



宁波凯普电子有限公司

Ningbo Kepo Electronics Co.,Ltd.

宁波东钱湖镇东钱湖工业区宝源路 25 号

TEL:+86-574-88370330 FAX:+86-574-88370329

No.25 Baoyuan road Dongqian Lake, Industry Area, Dongqian town, Ningbo City, China(Post Code:315121)

Sales@chinaacoustic.com www.chinaacoustic.com

Specification for Microphone	Page	2/8
	Revision No.	1.0
Model No. : KPCM-45H22LC33-56dB-1731-Green	Drawing No.	KIC1731

CONTENTS

1. Scope
1.范围
2. General
2.概要
3. Electrical and Acoustic Characteristics.
3.电声参数
4. Mechanical characteristics and environmental test
4.机械特性和环境试验
5. Measurement Block Diagram & Response curve
5.测试图和曲线图
6. Dimensions
6.尺寸图
7. Packing
7.包装
8. Revision
8.履历表

Specification for Microphone	Page	3/8
	Revision No.	1.0
	Drawing No.	KIC1731

Model No. : KPCM-45H22LC33-56dB-1731-Green

1. Scope 范围

This specification applies electret condenser microphone.

此规格书适用于电容式麦克风.

2. General 概要

- 2.1 Out-Diameter : 4.5 mm
- 2.1. 外径 : 4.5 mm
- 2.2 Height : 2.2 mm
- 2.2. 高度 : 2.2 mm
- 2.3 Weight : ≤0.3 g
- 2.3 重量 : ≤0.3 g
- 2.4 Operating Temperature range: '-20~+70°C without loss of function
- 2.4 工作温度: -20~+70°C
- 2.5 Store Temperature range: '-20~+70°C without loss of function
- 2.5 储存温度: -20~+70°C

3. Electrical and Acoustic Characteristics. 电声参数

Test condition : 15 ~ 35 °C, 45% ~ 85% RH, 860~1060 mbar

测试条件 : 15~35 °C, 45%~85%RH , 860 ~ 1060mbar

No	Items	Symbol	Unit	Specification	Condition
1	Directivity 指向性			Omni-directional 指向性	全
2	Sensitivity 灵敏度	S	dB	-56dB±3	0dB=1V/ubar,1KHz
3	Standard Operation Voltage 标准操作电压	Vs	V.D.C	2.0	
4	Output impedance 输出阻抗	Zout	KΩ	2.2	f=1KHz,1ubar
5	Max operating voltage 最大操作电压		V.D.C	10	
6	Sensitivity reduction 减压灵敏度	ΔS-Vs	dB	-3	f=1KHz,1ubar Vs=3.0-1.5V.D.C
7	Frequency 频率	f	Hz	100-10,000	
8	Max. Current Consumption 最大耗电电流	IDss	mA	0.5	Vs=2.0V,RL=2.2KΩ
9	Signal to noise ration 讯号对比杂音	S/N	dBA	58	f=1KHz,1ubar A weighted
10	Material 材质			AL 铝	
11	Terminal 端子				See appearance drawing请参 照外观尺寸图
12	Environmental Protection Regulations 环保法规			RoHS	

We use "Pascal (Pa)" indication of sensitivity as per the recommendation of I.E.C (International Electro technical Commission).The Sensitivity of "Pa" will increase 20dB comparing with "ubar" indication.

Example : -60dB(0dB=1v/ubar)=-40dB(1v/Pa)

依I.E.C.(国际电子协会) 建议, 以"Pa"为灵敏度标示单位比"ubar"灵敏度标示单位增加20dB

列如:-60dB(0dB=1V/ubar)=-40dB(1V/Pa)

I

Specification for Microphone

Page

4/8

Revision No.

1.0

Model No. : KPCM-45H22LC33-56dB-1731-Green

Drawing No.

KIC1731

4.1 Mechanical Characteristics 机械特性

No.	Item	Test Condition	Evaluation standard
1	Vibration 振动试验	To be no interference in operation after vibrations. 10Hz to 50Hz for 1 minute full amplitude 1.52mm, for 2 hours at three axes 1分钟频率变化从10Hz到50Hz,振幅在1.52mm,在三个方向测试振动2小时,产品应不受影响	After any tests,the sensitivity to be within $\pm 3\text{dB}$ 测试其灵敏度须与原测试值的差异不超过 $\pm 3\text{dB}$
2	DROP TEST 跌落测试	To be no interference in operation after dropped to concrete floor each one time from 1meterheight at three directions in state of packing 以正规包装的三个方向从1米高处自由落到混凝土地面时,产品应不受影响	

4.2 Environmental test 环境试验

No.	Item	Test Condition	Evaluation standard
1	High temperature test 高温测试	After being placed in a chamber at +70 °C for 72 hours. 置于+70 °C 环境中72小时.	After any tests,the sensitivity to be within $\pm 3\text{dB}$ of initial sensitivity after6H of conditioning at +25°C 经测试后麦克风,须静置于+25 °C (室温) 环境中2小时后,测试其灵敏度须与原测试值的差异不超过 $\pm 3\text{dB}$
2	Low temperature test 低温测试	After being placed in a chamber at -20°C for 72 hours. 置于-20 °C 环境中72小时.	
3	Humidity Test 相对湿度试验	After being placed in a chamber at +40°C and 90-95% relative humidity for 72 hours. 置于+40°C, 相对湿度90-95%环境中72小时.	
4	Impact test 冲击试验	The width of 11ms, acceleration 150M / S ² half sine pulse, 10 times in the three directions tested, sensitivity to be within $\pm 3\text{dB}$ from initial sensitivity 在宽度为11ms,加速度为150M/S ² 的脉冲半正弦波,在三个方向测试10次,灵敏度偏离范围在 $\pm 3\text{dB}$	

Standard Test Condition: a) Temperature: +15°C ~ +35°C b) Humidity: 45%-75% c) Pressure: 86 kPa - 106kPa

标准测试条件: a) 环境温度: +15°C ~ +35°C b) 相对湿度: 45%-75% c) 大气压力: 86 kPa - 106kPa

Judgement Test Condition: a) Temperature: (20 \pm 2)°C b) Humidity: 60%-70% c) Pressure: 86 kPa - 106kPa

判定测试条件: a) 环境温度: (20 \pm 2)°C b) 相对湿度: 60%-70% c) 大气压力: 86 kPa - 106kPa

5. Measurement Block Diagram & Response curve

测试图和曲线图

5.1 Measurement Block Diagram 测试图

Schematic Diagram $V_s = 2.0V$; $R_1 = 2.2K\Omega$

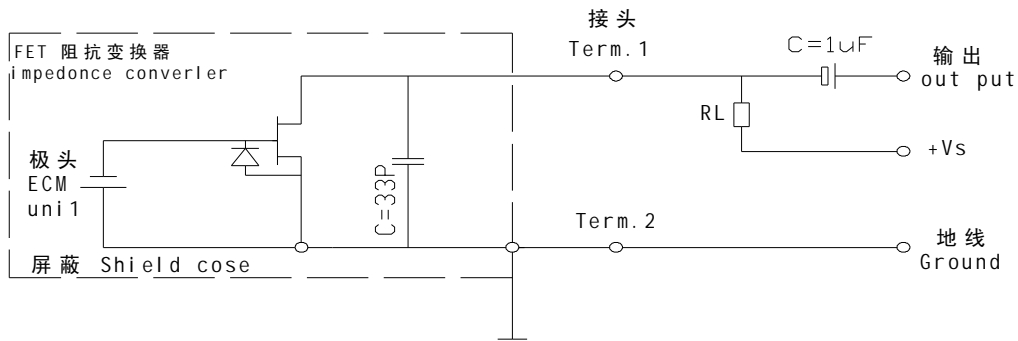

5.2 Response curve 曲线图

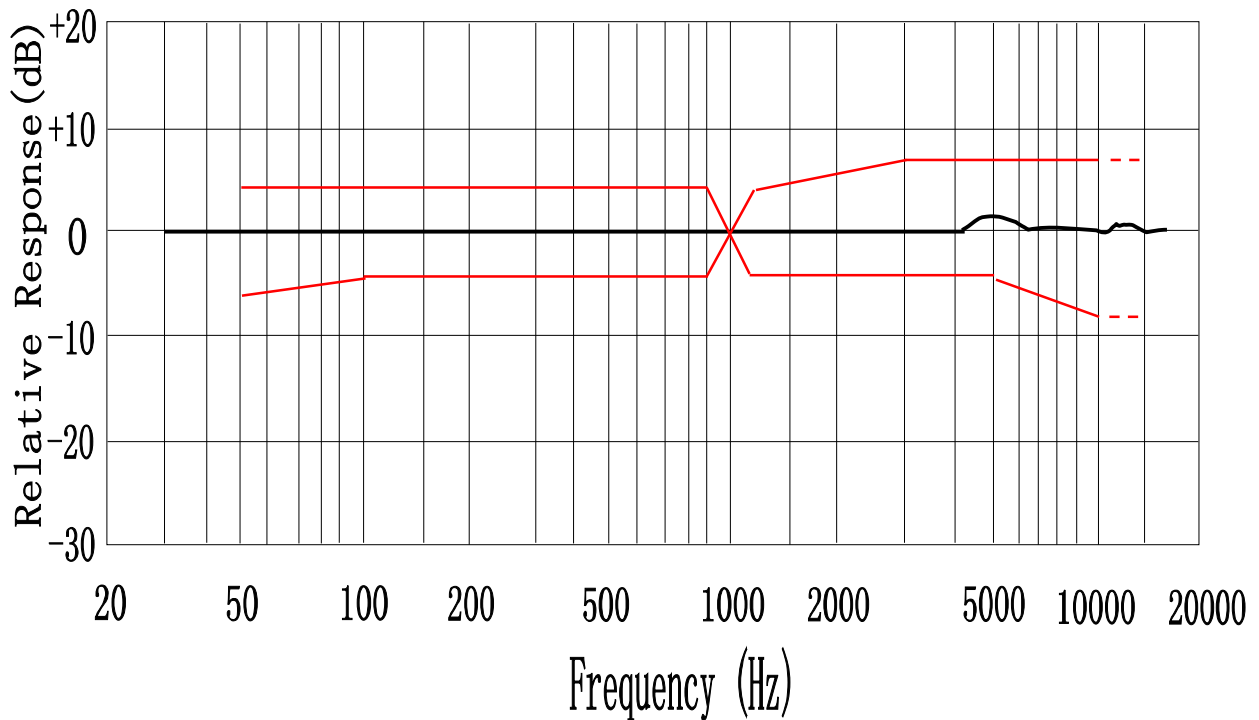

Specification for Microphone

Page

6/8

Revision No.

1.0

Model No. : KPCM-45H22LC33-56dB-1731-Green

Drawing No.

KIC1731

6. Dimensions 尺寸图

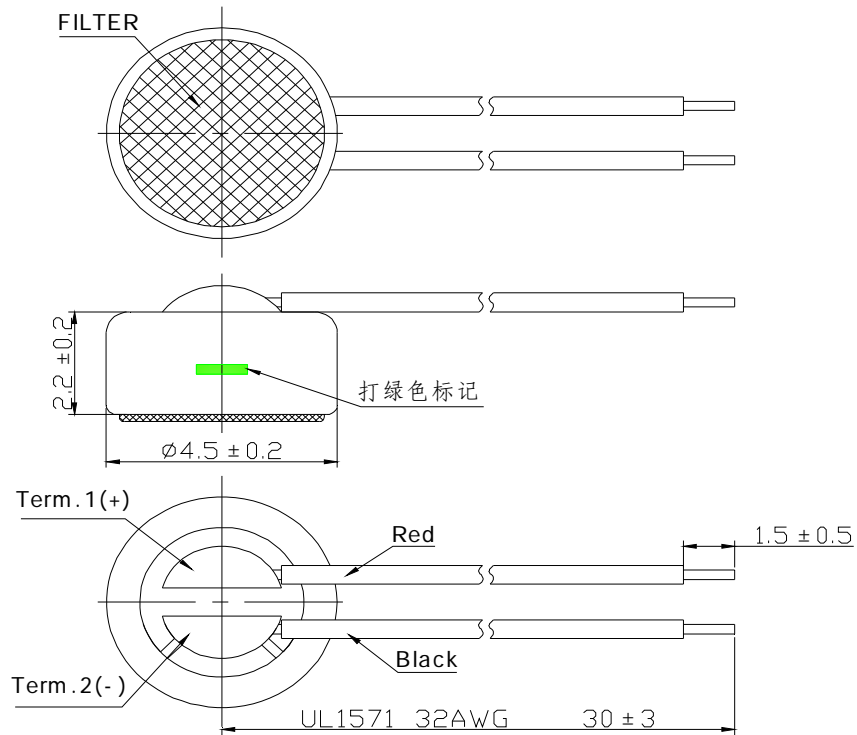

FIRST ANGLE PROJECTION

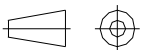

UNIT : mm

Tolerance : ± 0.2

Specification for Microphone	Page	7/8
	Revision No.	1.0
Model No. : KPCM-45H22LC33-56dB-1731-Green	Drawing No.	KIC1731

7. Packing 包装

Specification for Microphone	Page	8/8
Model No. : KPCM-45H22LC33-56dB-1731-Green	Revision No.	1.0
	Drawing No.	KIC1731

8. Revision 履历

Rev. No.	DATE	PAGE	DESCRIPTION	BOM
1.0	2013.01.23		Primary	